

LED 2023

RECESS MOUNTED LIGHT, SQUARE

0% 100%



Water Tolerant



- > Protected from water spray as a recess mounted light
- > Can be used as a surface mounted light using optional surface mount rings and wedges
- > Degree of Protection: IP44 recess; IP20 surface

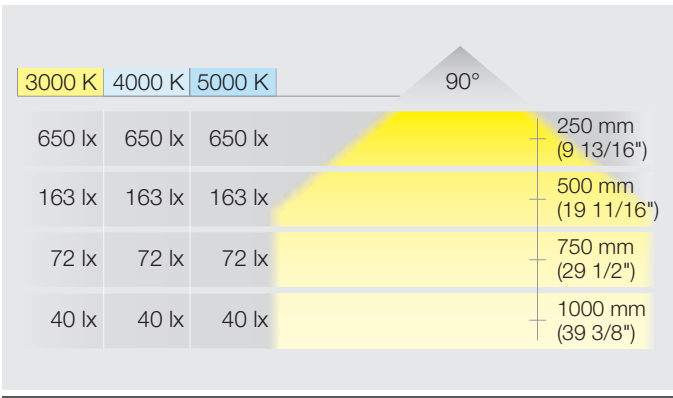

| Item No. | 833.72.060 | 833.72.064 | 833.72.061 | 833.72.065 | 833.72.062 | 833.72.066 |
|-----------------------------|---|-------------------------|------------------------|-------------------------|------------------------|-------------------------|
| SRP | \$20.00 | \$20.00 | \$20.00 | \$20.00 | \$20.00 | \$20.00 |
| Light Color (K) | 3000 (warm white) | | 4000 (cool white) | | 5000 (cool white) | |
| Drill hole | Ø26 mm (1 1/16") | | | | | |
| L x W x H | 30 x 30 x 14 mm (1 3/16" x 1 3/16" x 9/16") | | | | | |
| Wattage | 1.5 | | | | | |
| LEDs | 3 | | | | | |
| Lumen | 105 | | | | | |
| Lumen per watt | 70 | | | | | |
| CRI | 82 | | | | | |
| Energy Efficiency class | A+ | | | | | |
| Weighted energy consumption | 1.65 | | | | | |
| Material | Aluminum | | | | | |
| Finish | chrome-plated polished | silver colored anodized | chrome-plated polished | silver colored anodized | chrome-plated polished | silver colored anodized |
| Supplied with | 2 m (78 3/4") lead | | | | | |

Note Loox Lights and Drivers are "Suitable for use within Closet Storage Spaces"

LED 2023

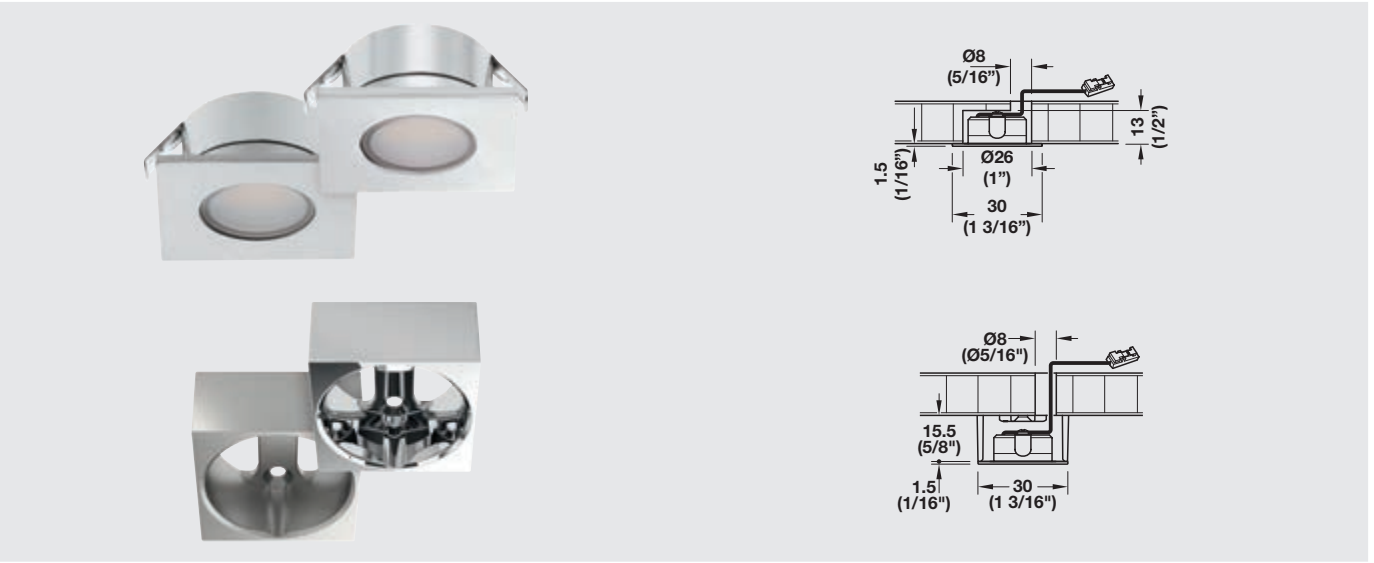

- > Dimmable
- > For mounting in drilled hole with clip fastener or for screw mounting



- > Driver see page 51
- > Drill bit see page 146



- Surface mounted trim ring, square, Plastic
- > silver colored
Item No. 833.72.834 **SRP \$4.00**
 - > chrome-plated
Item No. 833.72.835 **SRP \$4.00**

Note

IP20 protection with surface mounted trim ring.



LOOX LED DRIVER

CONSTANT VOLTAGE 12 V

12 V SYSTEM

THIN PROFILE

- 1 Item No. 833.74.960
 $\otimes_1 + \otimes_2 + \dots + \otimes_6 < 20 \text{ W}$
- 2 Item No. 833.74.962
 $\otimes_1 + \otimes_2 + \dots + \otimes_6 < 40 \text{ W}$
- 3 Item No. 833.74.964
 $\otimes_1 + \otimes_2 + \dots + \otimes_6 < 60 \text{ W}$
max. 42 W per light output

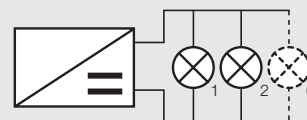

Parallel connection

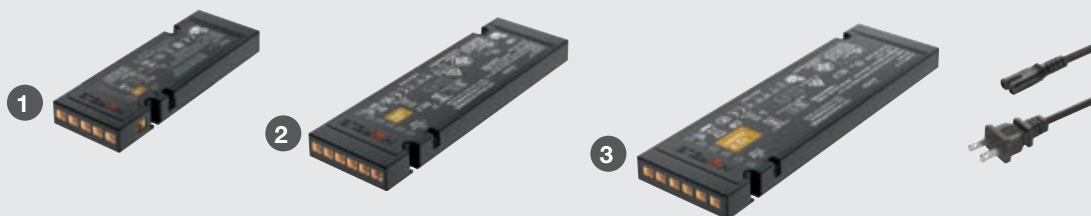

- > Suitable for all of the world's power systems
- > With an integrated port for a wide selection of switches
- > Max. 42 W per light output
- > Lead length from driver to switch: Max.: 6 m (236 1/4")

- ! > Class 2
- > Efficiency Level VI
- > Degree of protection : IP20
- > Loos drivers cannot be controlled by a dimmer wall switch

| Item No. | 833.74.960 1 | 833.74.962 2 | 833.74.964 3 |
|-----------------------------------|---|---|--|
| SRP | \$36.00 | \$60.00 | \$80.00 |
| L x W | 140 x 50 x 16 (5 1/2" x 2" x 5/8") | 190 x 60 x 16 (7 1/2" x 2 3/8" x 5/8") | 230 x 70 x 16 (9 1/16" x 2 3/4" x 5/8") |
| Wattage | 0 – 20 | 0 – 40 | 0 – 60 |
| Standby Power Consumption Wattage | <0.1 | <0.1 | <0.2 |
| Input voltage | 100 – 240 V~; 50 – 60 Hz | | |
| Output voltage | 12 V DC | | |
| Output current | 1.67 A | 3.33 A | 5.0 A |
| Number of slots | 6 for lights, 1 for switch, 1 for power cord | | |
| Material/Finish | Plastic, black | | |
| Supplied with | Mounting accessories, US power cord | | |
| Note | Loos Lights and Drivers are "Suitable for use within Closet Storage Spaces" | | |

- ➔ > Switches see pages 113 - 116
- > Extension leads see page 127

- + Power cord with 90° plug
2 m (78 3/4")
- > Item No. 833.89.017 **SRP \$5.00**

- 90° Plug adapter
- > Item No. 833.89.018 **SRP \$7.00**

| Country-specific 2 m (78 3/4") primary leads | | | | | | | | 3 m (118") |
|--|------------|------------|------------|------------|------------|------------|------------|------------|
| Item No. | 833.89.000 | 833.89.001 | 833.89.002 | 833.89.003 | 833.89.016 | 833.89.005 | 833.89.050 | 833.89.008 |
| SRP | \$10.00 | \$4.00 | \$4.00 | \$4.00 | \$4.00 | \$4.00 | \$4.00 | \$6.00 |
| Plug design | | | | | | | | |
| Designation | UK | AU | EU | US | JP | CN | US | US |
| Voltage (V) | 250 | 250 | 250 | 120 | 100 | 250 | 120 | 120 |

LED DRIVER

CONSTANT VOLTAGE PLUG-IN DRIVER

12 V SYSTEM

-  > Degree of protection: IP20
- > 4 m (157 1/2") lead
- > Class 2



| Item No. | 833.74.934 | 833.74.936 | 833.74.938 |
|----------------------------|--|---|--|
| SRP | \$12.00 | \$20.00 | \$30.00 |
| L x W x H | 61 x 37 x 43 (2 3/8" x 1 1/2" x 1 11/16") | 78 x 46 x 54 (3 1/16" x 1 13/16" x 2 1/8") | 84 x 50 x 58 (3 5/16" x 2" x 2 5/16") |
| Stand-by Power Consumption | 0.3 W | | |
| Input voltage | 100-240 V; 50-60 Hz | | |
| Output voltage | 12 VDC | | |
| Output current | 6 | 15 | 27 |
| Degree of protection | IP 20 | | |
| Number of slots | 1 socket for lead | | |
| Material/Finish | Plastic, black | | |

Note
Loox Lights and Drivers are "Suitable for use within Closet Storage Spaces"



- Secondary lead 12 V, Plastic, black with 2 connections
- > 4 m (157 1/2") Item No. 833.74.749 **SRP \$8.00**
 - > 2 m (78 3/4") Item No. 833.74.791 **SRP \$8.00**

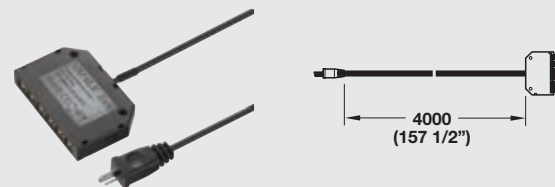

- Secondary lead 12 V, Plastic, black with 6-way distributor, 4 m (157 1/2")
- > Item No. 833.74.748 **SRP \$12.00**

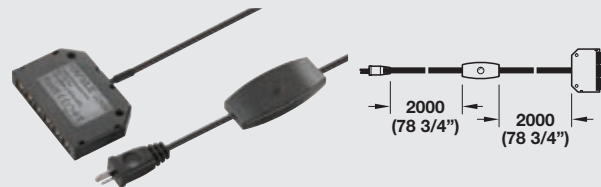

- Secondary lead 12 V, Plastic, black with dimmer and 6-way distributor
- > Item No. 833.74.709 **SRP \$30.00**

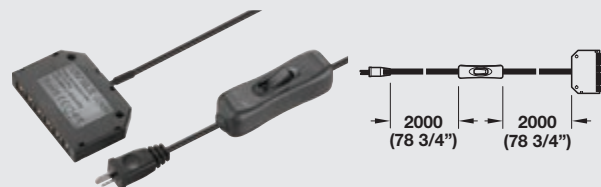

- Secondary lead 12 V, Plastic, black with rocker switch and 6-way distributor
- > Item No. 833.74.746 **SRP \$24.00**